



04-07. August 2022.

SUPPLEMENTARY REGULATIONS

ASN registration number / Visa
Visa No.: K-0511/2022.06.17.

Approved on: 17.06.2022

FIA VISA
Visa No.: 04EUBC/170622

Issued on: 17.06 2022

INDEX

| | | |
|-----------|---|----|
| Art. 1. | Introduction..... | 3 |
| Art. 1.1 | Preamble..... | 3 |
| Art. 1.2 | Length of Selective Sections..... | 3 |
| Art. 1.3 | Overall SS distance and total distance of the itinerary..... | 3 |
| Art. 1.4 | Average altitude..... | 3 |
| Art. 1.5 | Route Conditions (Selective Stages)..... | 3 |
| Art. 2. | Organisation..... | 3 |
| Art. 2.1 | Championships and titles for which the Baja counts..... | 3 |
| Art. 2.2 | Approvals..... | 3 |
| Art. 2.3 | Organiser's name, address, and contact details..... | 4 |
| Art. 2.4 | Organising Committee..... | 4 |
| Art. 2.5 | Stewards of the Meeting..... | 4 |
| Art. 2.6 | FIA Delegates & Observer..... | 4 |
| Art. 2.7 | Senior Officials..... | 4 |
| Art. 2.8 | Location of Rally HQ and contact details..... | 5 |
| Art. 3. | Programme in chronological order and locations..... | 5 |
| Art. 4. | Entries..... | 6 |
| Art. 4.1 | Closing date for entries..... | 6 |
| Art. 4.2 | Entry procedure..... | 7 |
| Art. 4.3 | Number of competitors accepted and vehicle classes..... | 7 |
| Art. 4.4 | Entry fees/entry fee packages..... | 8 |
| Art. 4.5 | Payment..... | 8 |
| Art. 4.6 | Entry fee refunds..... | 8 |
| Art. 5. | Insurance Cover..... | 9 |
| Art. 6. | Advertising and Identification..... | 9 |
| Art. 6.1 | Obligatory organiser's advertising..... | 9 |
| Art. 6.2 | Optional organiser's advertising..... | 9 |
| Art. 7. | Tyres..... | 10 |
| Art. 7.1 | Regulations regarding tyres which may be used during the event..... | 10 |
| Art. 8. | Fuel..... | 10 |
| Art. 9. | Administrative checks..... | 10 |
| Art. 9.1 | Documents to be presented:..... | 10 |
| Art. 9.2 | Timetable..... | 10 |
| Art. 10. | Scrutineering, Sealing and Marking..... | 11 |
| Art. 10.1 | Scrutineering, venue and time..... | 11 |
| Art. 10.2 | Mud flaps..... | 11 |
| Art. 10.3 | Drivers' safety equipment..... | 11 |
| Art. 10.5 | Installation of the Safety Tracking System and Navigation System..... | 11 |
| Art. 11. | Other procedures and regulations..... | 12 |

| | | |
|------------|---|----|
| Art. 11.1 | Ceremonial start procedures and order..... | 12 |
| Art. 11.2 | Start Area..... | 12 |
| Art. 11.3 | Finish procedures..... | 12 |
| Art. 11.4 | Permitted early check-in..... | 12 |
| Art. 11.5 | Super Special Stage, regulations and order..... | 12 |
| Art. 11.6 | Road books delivery..... | 13 |
| Art. 11.7 | Special procedures and activities..... | 13 |
| Art. 11.8 | Official time used during the event..... | 13 |
| Art. 11.9 | Electronic start procedure at the start of a Selective Section..... | 13 |
| Art. 11.10 | Service..... | 13 |
| Art. 11.11 | Speed Control Zones..... | 14 |
| Art. 11.12 | Shakedown..... | 14 |
| Art. 11.13 | Onboard Camera..... | 14 |
| Art. 11.14 | Briefing..... | 14 |
| Art. 11.15 | Reconnaissance..... | 14 |
| Art. 12. | Identification of officials..... | 15 |
| Art. 13. | Prizes..... | 15 |
| Art. 14. | Final checks / Protests / Appeals..... | 15 |
| Art. 14.1 | Final Checks..... | 15 |
| Art.14.2 | Protest deposit..... | 15 |
| Art. 14.3 | Appeal deposit..... | 15 |

| | |
|-------------------|--|
| Appendix 1 | Itinerary |
| Appendix 2 | Names and photographs of the Competitors Relation officer(s) and their schedules |
| Appendix 3 | Decals and positioning of supplementary advertising |
| Appendix 4 | Extract from FIA Appendix L relating to overalls, helmets and any other safety requirements |
| Appendix 5 | Instruction for the use of the Tracking System |
| Appendix 6 | Kit components and Instructions for the use of the car-to-car communication system |

Art. 1. Introduction

Name of the event: 19th HunGarian Baja 2022

Date of the event: 04-07.August.2022.

Art. 1.1 Preamble

This event will be run in compliance with the FIA International Sporting Code (ISC) including appendices, the General Prescriptions applicable for all FIA Championships, the FIA Cross-Country Rally Sporting Regulations including appendices, the WADA/NADA Codes, and the FIA Anti-Doping Regulations, as amended from time to time. The National Road Traffic Regulations of the countries the event passes shall apply. Unless provided otherwise by these Supplementary Regulations, the provisions of the above Rules and Regulations shall apply.

Any modifications, amendments and/or additions to the Rules and Regulations shall be made in the form of numbered and dated bulletins. Additional information will be published in the Rally Guide. All FIA regulations can be found at <https://www.fia.com/regulations> .

The various documents will be written in English and Hungarian. In case of any discrepancy the English text will be binding.

Art. 1.2 Length of Selective Sections

Leg 1: 283,39 km

Leg 2: 132,52 km

Art. 1.3 Overall SS distance and total distance of the itinerary

| | | |
|--------------------------------------|--------|----|
| Number of Legs | 2 | |
| Number of Sections | 5 | |
| Number of Selective Sections | 5 | |
| Total distance of the itinerary | 565,54 | km |
| Overall length of Selective Sections | 415,91 | km |

Art. 1.4 Average altitude

The average altitude of the event is 250m

Art. 1.5 Route Conditions (Selective Stages)

According to FIA CCRSR 6.6.2 - safety type B

| | | |
|--------------------|-----|---|
| Gravel/dirt tracks | 100 | % |
| Other surfaces | 0 | % |

Art. 2. Organisation

Art. 2.1 Championships and titles for which the Baja counts

FIA European Cup for Cross-Country Bajas
FIA CEZ Cross-Country Championship
Hungarian Cross-Country Rally Championship

Art. 2.2 Approvals

ASN registration number / Visa

Visa No.: K-0511/2022.06.17.

Approved on: 17.06. 2022

FIA VISA

Visa No.: 04EUBC/170622

Issued on: 17.06.2022

Art. 2.3 Organiser's name, address, and contact details

Organiser: Garilla Racing Kft.
Co-Organiser: Garzone s.r.o
Organiser's representative: Mr. Zoltán Garamvölgyi
Street/P.O. Box: Házgyári str.1.
Post code/city: 8200 / Veszprém
Phone and fax: +36 30 79 14270
E-mail: info@hungarianbaja.com

Art. 2.4 Organising Committee

Organising Committee: Mr. Zoltán GARAMVÖLGYI Chairman of the Organizing Committee
Mrs. Márta TALABÉR
Mr. Roland PÁLINKÁS
Mr. György MÁRIA
Mr. Ferenc SCHEIBENHOFFER

Art. 2.5 Stewards of the Meeting

| | Name | License no. |
|--------------------------------------|------------------------|--------------------|
| Stewards of the Meeting (Chairman): | Mr. Arnas PALIUKENAS | |
| 2 nd FIA Steward/Observer | Mr. Wolfgang GASTORFER | FIA-STW-019-000109 |
| ASN Steward | Mr. Tibor OROSZLÁN | 10021 H |
| Assistant to the Stewards | Ms. Andrea ZÓLYOMI | |

Art. 2.6 FIA Delegates & Observer

| | Name |
|------------------------|------------------|
| FIA Technical Delegate | Mr. Janez FLERIN |

Art. 2.7 Senior Officials

| | Name | License no. |
|---------------------------------------|--------------------------------|-------------|
| Event Director: | Mr. Zoltán GARAMVÖLGYI | |
| Clerk of the Course: | Mr. Péter FALUVÉGI | 10012 H |
| Deputy Clerk of the Course: | Mr. János FALICS | 762 H |
| Secretary of the Event: | Ms. Julianna TÖRÖK | |
| Chief Safety Officer: | Mr. Sándor NÉMETH | |
| Deputy Chief Safety Officer: | Mr. Ferenc SCHEIBENHOFFER | |
| ASN Technical Delegate | Mr. Tibor SZABADOS | 11045 H |
| Scrutineers (Chief Scrutineer): | Mr. Szabolcs SOLTI | [Number] |
| Scrutineer | Mr. István SOLTI | [Number] |
| Chief Medical Officer (CMO): | Dr. Ádám RADVÁNYI | |
| Timekeeping (Chief Timekeeper): | Mr. Csaba GLÜCK - CHRONOMOTO | |
| Competitors' Relations Officer (CRO): | Mrs. Brigitta VARGA | |
| | Mr. István MÁTRAI | |
| | Mrs. Marianna MAGYAR KELEMENNÉ | |
| Press Officer: | Ms. Anita TÓTH | |
| GPS | STELLA | |
| Environmental Officer: | Mr. Péter BAKÓ | |

Art. 2.8 Location of Rally HQ and contact details

Name: Thury Castle
Street: Hunyadi Mátyás Square 1.
Post code, city: 8100, Várpalota
Phone and fax: (06 88) 472 305
E-mail: info@hungarianbaja.com

Rally HQ in operation: from 04.08.2022 at 09:00 to 07.08.2022 at 15:30
Service parc in operation: from 03.08.2022 at 16:00 to 07.08.2022 at 15:30
Official Notice Board (NB): does not apply
Digital Notice Board (DNB): [sportity](#), results: www.chronomoto.hu, www.hungarianbaja.com



On PC: https://webapp.sportity.com/channel/HGB22_FIA

Art. 3. Programme in chronological order and locations

| | Location: | Date: | Time: | | |
|---|--|-------------|-------------|------------|-------------|
| Publishing of the supplementary regulations | www.hungarianbaja.com | | | | |
| Entries open | Garilla Racing Kft. 8200 Veszprém, Házgyári str.1. +36307914270 info@hungarianbaja.com www.hungarianbaja.com | 01.06.2022. | 10:00 | | |
| Organiser's office opening | | | | | |
| Media Accreditation Start | | 11.07.2022 | 24:00 | | |
| Issuing of Rally Guide | | | | | |
| Closure date of entries at reduced fees | Thury Castle, Várpalota | 27.07.2022 | 10:00 | | |
| Closure date of entries | | | | 03.08.2022 | 16:00-20:00 |
| Closing date for order of extra service in SP | | | | | |
| Closing date for shakedown registration | Rally Office, Thury Castle | 04.08.2022 | 08:00-19:00 | | |
| Pre Event Press conference | | | | | |
| Publication date of entry list | | | | | |
| Registration, Check List and Service Plate delivery | | | | | |
| Service Park Opening | | | | | |
| Registration, Check List and Service Plate delivery | | | | | |
| Service Park Re-Opening | | | | | |
| HQ Opening | | | | | |
| Opening of media centre | | | | | |
| Collection of rally safety tracking system | | | | | |
| Administrative Checks | | | | | |
| Collection of material and documents | | | | | |

| | | | |
|--|--------------------------------------|------------|--|
| Scrutineering – sealing & marking of components | Suzuki Mészáros, Grábler Tó str. 10. | 04.08.2022 | 10:00-21:00 |
| Publication of list of cars eligible to start | Digital Notice Board | | 21:30 |
| Re-scrutineering for car which did not pass | Várpalota Főtér, Szabadság square PF | 05.08.2022 | 08:00 |
| HQ Opening | Rally office, Thury Castle | | 08:00 |
| Opening of media centre | | | |
| Shakedown | TBA | | 09:00-13:00 |
| Entry to the Parc Fermé- Start Area | Várpalota Főtér, Szabadság square | | 12:00-15:00 |
| Press Conference before the Baja | | | 15:15 |
| Team managers and/or Drivers' briefing Issuing of the road book, maps | Thury Castle, Várpalota | | 16:45 |
| Publication of start list for Leg 1 | Digital Notice Board | | |
| Start of the Rally – Leg 1, Section 1 | Várpalota Főtér, Szabadság square | | 17:45 |
| Publication of provisional classification of QS | Digital Notice Board | | 19:45 |
| Publication of final classification of QS | | | 20:15 |
| Choosing starting position of Leg 2 | Várpalota Főtér, Szabadság square | | 20:30 |
| Publication of start list for Ceremonial start Leg 1 | Digital Notice Board | | 21:00 |
| Ceremonial Start | Várpalota Főtér, Szabadság square | | 21:30 |
| Finish of Leg 1, Section 1 (estimated time of 1st car) | Várpalota | | 22:00 |
| Publication of the Results Leg 1, Section 1 | Digital Notice Board | | |
| Publication of start list for Leg 1, Section 2 | | 23:00 | |
| Closing date for the HQ | Thury Castle, Várpalota | | |
| HQ Opening | Thury Castle, Várpalota | 06.08.2022 | 07:00 |
| Opening of media centre | | | 08:30 |
| Re-scrutineering, cars to re-start after retirement | | | 10:10 |
| Start of Leg 1, Section 2 | Várpalota Főtér, Szabadság square PF | | 18:40 |
| Finish of Leg 1 (estimated time of 1 st car) | | | |
| Publication of Results Leg 1. | Digital Notice Board | | 18:45 |
| Publication of start list for Leg 2, Section 4 | | | 19:00 |
| Closing date for the HQ | Thury Castle, Várpalota | | |
| HQ Opening | Thury Castle, Várpalota | 07.08.2022 | 07:00 |
| Opening of media centre | | | 08:30 |
| Re-scrutineering, cars to re-start after retirement | | | 10:00 |
| Start Leg 2, Section 4 | Várpalota Főtér, Szabadság square PF | | 15:30 |
| Finish of Leg 2 (estimated time of 1 st car) | | | Immediate after arrival in the finish |
| Final scrutineering (following the marshals' instructions) | Suzuki Mészáros, Grábler Tó str. 10. | | 16:30 |
| Publication of Provisional Classification | Digital Notice Board | | After the Stewards have declared the Classification final. |
| Publication of Final Classification | Digital Notice Board | | |
| Prize-giving Celebrating Podiums Ceremony | Várpalota Főtér, Szabadság square | | 17:00 |

Art. 4. Entries

Art. 4.1 Closing date for entries

See programme in chronological order (SR Art. 3) and FIA CCRSR Art.17.2 CCSR is 24.07.22

Art. 4.2 Entry procedure

Entries must be submitted in accordance with the FIA CCRSR Art. 16 – Art. 18.

See also FIA International Sporting Code Art. 3.8 – Art. 3.14

Entries can be submitted on an electronic entry application (Internet) on the organisers' website www.hungarianbaja.com. The original duly signed entry form must reach the organisers within 5 days following the close of entries.

Mailing address for Entry Form:

Name: Garilla Racing Kft,

Street: Házgyári str.1.

Post code/city: 8200 / Veszprém

E-mail: info@hungarianbaja.com

An entry application will be accepted only if accompanied by the total entry fees. The entry fee must be credited in full to the organiser's bank account.

According to the FIA International Sporting Code, foreign competitors/drivers must have their ASN's permission, which should be attached to the entry form (ASN's stamp on the entry, or the ASN's written permission to take part in the competition, or the licences copies with the described permissions in them)

In addition to the completed application, it is necessary to send scan copies by e-mail to julianna@hungarianbaja.com of:

- Entry fees (copy of bank transfer).
- Competitors licence
- Drivers and co-drivers ASN licences, as well as passports or national identification.
- Insurance
- Certificate of vehicle ownership or written authorisation from the owner.

Art. 4.3 Number of competitors accepted and vehicle classes

Art. 4.3.1 The number of competitors shall be limited to: *maximum 60 of cars*

The minimum number of entered cars required is.: *30 of cars*

"If that number is not reached, the Organiser may cancel the competition after obtaining the FIA's approval."

Art. 4.3.2 Eligible cars

- **Group T1:** Prototype Cross-Country Cars, complying with Appendix J Article 285.
- **Group T2:** Series Production Cross-Country Cars, complying with Appendix J Article 284. Vehicles must also comply with Appendix IV of FIA CCRSR.
- **Group T3:** Lightweight Prototype Cross-Country Vehicles, complying with Appendix J Art. 286.
- **Group T4:** Modified Production Cross-Country Side-by-Side Vehicles, complying with Appendix J Article 286A.

Art. 4.3.3 Groups/Classes of vehicles

| Group | Class | Vehicle |
|-------|-------|--|
| T1 | T1.1 | T1 4x4 Petrol and Diesel |
| | T1.2 | T1 4x2 Petrol and Diesel |
| T2 | | Series Production Cross-Country Cars - Petrol and Diesel |
| T3 | | Lightweight Prototype Cross-Country Vehicles |
| T4 | | Modified Production Cross-Country Side-by-Side Vehicles, complying with Appendix J Article 286A." (Art. 4.3.2 & 4.3.3) |

See also FIA CCRSR Art. 8 for additional provisions.

Only above listed cars are eligible to score points in the FIA European Cup for Cross-Country Bajas.

Art. 4.4 Entry fees/entry fee packages

4.4.1. With organiser's optional advertising (see also FIA CCRSR Art. 20):

EUR 2200 **payment transferred** up to entry closing date with reduced entry fee: **11.07.2022**
EUR 2600 up to entry closing date: 25.07.2022

Without organiser's optional advertising: (see also FIA RRSR Art. 20):

EUR 4000 **payment transferred** up to entry closing date with reduced entry fee: 11.07.2022
EUR 4800 up to entry closing date: 25.07.2022

The entry fee includes:

- Additional compulsory liability insurance
- Basic service plate/competing vehicle(1)
- Basic service area per vehicle (50m²)
- Arm bands to the team mechanics(3)
- Rent of GPS navigation and safety tracking system (STELLA)

4.4.2. To be payed on site:

- **Deposit** for the GPS navigation and safety tracking system: 100 €
- GPS navigation and safety tracking system's **installation kit**: 60€

4.4.3. Other fees:

- Additional permission to the service park (Assistance sticker / service plate): 200 €
- Additional service area (50m²): 100 €
- Waterproof Road Book 100 €
- Team Entry 350 €
- Shakedown 200 €

The request of the Additional "Assistance" stickers must be done on the Entry Form, or to the Organizer before the closing date for entries, and have paid the fee for each additional service vehicle.

Art. 4.5 Payment

Any entry not accompanied by the entry fee shall be, according to Art. 3.9.3 of FIA International Sporting Code, null and void. The entry fee shall be paid by bank transfer to the account indicated below (the adequate proof of payment must be attached to the entry form):

Organiser's bank details:

| | |
|----------------------------|----------------|
| Slovenská Sporitelna, a.s. | Garzone s.r.o |
| Bank | Account holder |
| SK2609000000005063476359 | GIBASKBX |
| IBAN | BIC |

Payment details: HunGarian Baja 2022 and full name of the Driver

Any entry which is not accompanied with the entry fee will be considered as a preliminary one.

Art. 4.6 Entry fee refunds

The entry fee shall be refunded in full

- if the event does not take place
- to teams whose entry application is rejected

The organiser may partially refund entry fees, if a competitor cannot take part in the event due to a duly proved case of force majeure.

The deduction will be:

- 50% of the entry fee for the requests received until 20 days before the administrative checks.
- 100% of the entry fee for the requests received less than 19 days before the administrative checks.

Art. 5. Insurance Cover

Insurance will be done in accordance with Art. 15 of the 2022 FIA CCRSR.

Name of the insurance company: SRC SPECIAL RISK CONSORTIUM GMBH, Kuniberts kloster 7-9, D 50668 KÖLN.

The limit of the responsibility is 3.000.000 Eur.

- In case of an accident leading to insurance event, the competitor or his representative must make a written statement to the Clerk of the Course, the Competitors Relations Officer, or directly to the Organizer, within 24 hours. This statement must mention the accident circumstances, the names and addresses of the casualties, as well as contact details of the witnesses.
- Competitors are reminded that only damage caused by the organizers and named drivers are covered by the Organization's insurance policy. Loss or injury that may be suffered by the drivers themselves or participating vehicles is EXCLUDED.
- Irrespective of this Third Party insurance, entrants and drivers are free to take out the policies they deem fit on their own account and at their own discretion.
- Service vehicles, including those displaying the plates supplied by the Organization, shall under no circumstances be deemed participating vehicles. They are therefore not covered by the Organization's insurance policy and responsibility for them lies solely with their owners.
- The insurance cover will come into effect from the administrative checking and scrutineering for the Event and end upon the expiry of one of the following time limits, whichever is the later:
 - time limit for protests or appeals or the end of any hearing by the Stewards;
 - end of the administrative checking and postevent scrutineering;
 - end of the prize-giving.

The Organization refuses all responsibility stemming from the consequences of infractions of the law, regulations and decrees of Hungary, committed by Competitors or their service crew, which must be exclusively borne by them.

Art. 6. Advertising and Identification

See Appendix 3 of these SR "Decals and positioning of supplementary advertising".

Art. 6.1 Obligatory organiser's advertising

The organiser will provide each crew with the number identification (67x22cm), which must be affixed to their car in the stated positions prior to scrutineering. Each panel shall be placed horizontally at the leading edge of each front door, with the number at the front. The top of the plate shall be between 7 cm and 10 cm below the lower limit of the window. **It is not allowed to cut the panel.**

Rally plate:
HunGarian Baja 2022

Competition number size: 67 x 22 cm
HunGarian Baja 2022 logo

Competition number size (roof panels): 50 x 52 cm

Windshield sticker: 2 pc. 25x10cm
1. Will be published in Bulletin
2. Will be published in Bulletin

Art. 6.2 Optional organiser's advertising

Additional organiser's advertising: TBA
Will be published in a Bulletin.

Size: 50x50cm
For T3, T4: 30x30cm

Art. 7. Tyres

Art. 7.1 Regulations regarding tyres which may be used during the event

See Art.10 of the FIA CCRSR and Art. 10 of Appendix V2 of the FIA CCRSR

The number of tyres to be used by FIA T1 Priority drivers is **12** [*after agreement of FIA*]

Art. 8. Fuel

Refuelling is permitted only in commercial fuel stations using fuel on sale to the public. Only the crew may carry out this procedure. Refuelling stations authorised will be indicated in the Road Book with "FUEL STATION".

All type of fuel must follow Appendix J Art. 252.9. (Art. 57 of the FIA CCRSR).

The use of the fuel quick couplings (Stäubli SPT12 type) is mandatory for T3 and T4 group vehicles, according to the art. 57.2.1 of the 2022 CCR SR.

Art. 9. Administrative checks

Before Administrative Check, each vehicle must **Register** at Suzuki Mészáros, Grábler Tó str.10, where the Checklist and Service Plates will be provided.

Art. 9.1 Documents to be presented:

To minimize the time required for administrative check, please make a photo or scan copies of the documents required, and send them to the following email address: julianna@hungarianbaja.com. Make sure to bring and present the following documents:

- Competitors' licence
- Driver's and co-driver's competition licences
- Driver's and co-driver's ID cards/passports
- Driver's and co-driver's valid driving licences valid for the vehicle entered
- ASN authorisation for foreign competitors (if required)
- Completion of all details on the entry form
- Car registration papers
- Car insurance cover
- FIA Technical Passport (or ASO Technical Passport)
- FIA Homologation form for T2 vehicles
- Authorization from the owner (if not the driver)

Art. 9.2 Timetable

See programme (SR Art. 3)

The following additional procedures will apply:

- Administrative checks should, whenever possible, be carried out together with the collection of rally materials and documents.
- Notwithstanding Art. 22.1 of FIA CCR SR, drivers and co-drivers are not required to report personally to the administrative checks. Each Competitor shall nominate in advance to the Rally Organizer one authorized representative to complete administrative checks and collect the rally materials and documents, provided in plastic bags. In order to receive the package, administrative checks must be fully completed.

The original documents required for the Administrative Check must be presented for visual inspection.

Individual times for administrative checks will be published for each competitor in 'Organizer's communication' and published on the website: www.hungarianbaja.com, and Sportity

A time control before the Administrative Checks (C1) will be arranged, according to the individualized timetable.

Any delay to the C1 control will be penalized as follows:

- From 1 to 15 minutes: 150€ fine

- From 16 to 30 minutes: 250€ fine
- From 31 to 60 minutes: 500€ fine
- More than 60 minutes: 500€ fine and report to the Stewards.

Art. 10. Scrutineering, Sealing and Marking

See Article 23 and Article 24 of the FIA CCRSR.

Art. 10.1 Scrutineering, venue and time

Location: Suzuki Mészáros, Grábler Tó str. 10.

Time: 04.08.2022. 10:00-21:00 according to scheduled time for each crew!

Cars may be presented at scrutineering by a representative of the team. See programme (SR Art. 3) An individual schedule will be published in the website www.hungarianbaja.com, and Sportity. Please notice, that with respect to Appendix S ISC FIA, Scrutineering – 1 or max 2 people for car, (2 to remove underbody protection / 1 person for checking the equipment / 1 person for sealing spare parts). PPE is required for all team entering scrutineering.

There will be a time control before the Scrutineering (C2). The competitors should check-in to this time control according the individual schedule.

Any delay to the C2 control will be penalized as follows:

- From 1 to 15 minutes: 150€ fine
- From 16 to 30 minutes: 250€ fine
- From 31 to 60 minutes: 500€ fine
- More than 60 minutes: 500€ fine and report to the Stewards.

Art. 10.1.1 Scrutineering, mandatory documents

- Cars' complete original FIA Homologation Document (if applicable)
- FIA Technical Passport (or ASO Technical Passport)
- SOS / OK board (DIN A3 format)

The installation of the tracking system will be checked at scrutineering.

Art. 10.1.2 Timetable for scrutineering

See programme (SR Art. 3)

Schedule will be published same time as Entry List on www.hungarianbaja.com, and on Sportity

Art. 10.2 Mud flaps

According Art. 25.3.4 of the FIA CCRSR, the use of mud flaps in compliance with the Art 283-19 is compulsory.

Art. 10.3 Drivers' safety equipment

All items of clothing including helmets and FHR (Front Head Restraint) intended to be used, e.g. HANS devices, must be presented for scrutineering. They shall be checked for compliance with Appendix L, Chapter III. In compliance with Art.48.1.and Appendix III of 2022 FIA CCRSR the medical kit and survival kit (the medical kit must come from the FIA technical list No. 83.) are mandatory.

Art. 10.4 Special national requirements

According the hungarian traffic rules, using headlight is compulsory on the road sections and in selective sections too.

Art. 10.5 Installation of the Safety Tracking System

Art. 10.5.1 Tracking System

All vehicles must **only** be fitted with the Safety Tracking System(s) provided by the Organiser. The instruction for the use of the Tracking System is in the Appendix 5 of these Supplementary Regulations. The system will be collected either by the crew or a representative and must be installed before the car is brought to scrutineering. All the damage caused for the rally safety tracking equipment will be invoiced afterwards.

Art. 10.5.2 Navigation System (NAV-GPS)

Competitors are obliged to be equipped with one or two Navigation System(s) (NAV-GPS) downloaded with

the waypoints given by the Organiser. When a crew uses two NAV-GPS, it must indicate in writing, at scrutineering, which of the two will be considered as the official one.

Regulations regarding the use and installation of a NAV-GPS; Appendix 5 and 6

Art. 10.5.3 Connection of the Systems (FIA CCRSR Art. 12.3)

The specifications for the standard power connector are laid down in the FIA CCRSR Appendix VI.

It is the competitor's responsibility to ensure that the Safety Tracking System(s) and the NAV-GPS always remain permanently connected and switched on with the antenna connected throughout the duration of the competition.

Art. 11. Other procedures and regulations

Art. 11.1 Ceremonial start procedures and order

The event Grand Opening Ceremonial Start will be held at 21:30 5th August, at the front of Thury Castle. After the ceremony, crews proceed to Parc Ferme.

Art. 11.2 Start Area

See Programme, SR Art.3

Art. 11.3 Finish procedures

At the end of Leg2, the crews must place the vehicles in Parc Fermé, located in Várpalota Főtér, Szabadság square, according time schedule of the event on Sunday, 7th August.

Art. 11.4 Permitted early check-in

All TCs Parc Ferme IN at the end of a Leg (TBA)

Art. 11.5 QS – Qualifying Stage

| <i>Race Number / Super Special Stage starting order</i> | |
|--|------------------------------------|
| <i>T1</i> | <i>FIA Priority Drivers</i> |
| <i>T1</i> | <i>ASN Priority Drivers</i> |
| <i>T1</i> | <i>Others</i> |
| <i>T3</i> | <i>FIA Priority Drivers</i> |
| <i>T3</i> | <i>ASN Priority Drivers</i> |
| <i>T3</i> | <i>Others</i> |
| <i>T4</i> | <i>FIA Priority Drivers</i> |
| <i>T4</i> | <i>ASN Priority Drivers</i> |
| <i>T4</i> | <i>Others</i> |
| <i>T2</i> | <i>FIA Priority Drivers</i> |
| <i>T2</i> | <i>ASN Priority Drivers</i> |
| <i>T2</i> | <i>Others</i> |

The Qualifying Stage will be held on 05th August 2022. 17:45.

The starting order will be according to Art. 32.1 and Art. 32.3 of the FIA Cross-Country Rally Sporting Regulations. The Qualifying Stage will be run as SS 1 according to Art. 33 of the FIA Cross-Country Rally Sporting Regulations.

Art. 11.6 Road Book delivery

Road books delivery for all Legs will take place on Friday, 05 August 2022, at the Briefing from 16:45.

Art. 11.7 Special procedures and activities

Art. 11.7.1 Availability of participants

Participants who park their vehicles in the Parc Fermé upon passing the finish line, must remain available by phone (mobile) until the final classification have been posted.

Art. 11.7.2 Classification

The final classification will be published on the website on the Digital Notice Board [sportity](#) and [www.chronomoto.hu](#), [www.hungarianbaja.com](#)

Art. 11.8 Official time used during the event

The official time is the GPS time. (GMT+1)

Art. 11.9 Electronic start procedure at the start of a Selective Section

The start of the selective section is happening based on an electric clock and lamp, connected to a false start alert system.

When the car arrives at the start line, the front of the car should be positioned behind a stick placed by the marshal to define the exact start position. One minute before the start time, but not before the car has stopped in its exact position, the marshal shall remove the stick and the crew shall refer to the automatic countdown clock. Any subsequent change of the car's position until its start time is not permitted and will be reported to the Stewards.

Art. 11.10 Service

Art. 11.10.1 Service Areas / Bivouacs

Access to the service park will only be permitted for vehicles, identified by the Organizer, showing the Service Plates, provided by the Organizer at the Registration. Accompanying team cars can enter only by purchasing a 200€ sticker at the Administrative Checks(1 service plate/team is provided by the organizer).

Tampering with or falsification of these plates will lead to disqualification of the team to which these service vehicles belong, on the decision of the Stewards. Plates will be placed in a visible area inside of the front windscreen of the vehicle.

Work on a competing car will be permitted only at service areas specified by the Organization.

LOCATION: Várpalota, Fehérvári str.17

Number of team members working in the Service Park and their identification are in accordance with V2-Art. 50.2.4. of the 2022 FIA CCRSR.

They must wear the armbands provided by the Organizer at ADMINISTRATIVE CHECK.

Car wash and Refuelling is strongly prohibited in the total area of the service park!!! Only possibility to wash the cars on the side of Service Park by yourself in the official car wash company.

The maximum speed allowed in the service park is 30 km/h in accordance with Art.51.3.of the 2022 FIA CCRSR. In case of a violation of this regulation by any vehicle/team member related to a competitor, the competitor will be penalized with 10 seconds per km/h over the speed limit.

Art. 11.10.2 Flexi Service: *Not applicable*

Art. 11.10.3 Service allowed in Selective Section: *Not applicable*

Art. 11.10.4 Tyre Fitting Zone: *Not applicable*

Art. 11.10.5 Fuel and Refuelling Zone

Refuelling is permitted only in commercial fuel stations using fuel on sale to the public at this fuel station. Only the crew may carry out this procedure. The Refuelling station authorised will be indicated in the Road Book with “FUEL STATION”.

On SS2A, SS2B and SS3A, SS3B will be a Neutralization Zone for all Competitors and a separate Remote Refuelling Zone (RRZ) for NATIONAL T3 & T4 vehicles only.

Art. 11.11 Speed Control Zones: *Not applicable*

Art. 11.12 Shakedown

01. 06. 2022. Friday Opening date for shakedown's entries
25. 07. 2022 Monday Closing date for shakedown's entries
04. 08. 2022 Thursday 08.00-19.00 Delivery Shakedown's materials (Identification plates – Road Book
Friday 05 August 09:00 to 13:00 Shakedown Length: 4km

ENTRY PROCEDURE: Anybody wishing to perform the Shakedown must indicate on the Entry Form, or inform via email the secretariat of the Event: info@hungarianbaja.com

REGISTRATION FEE FOR SHAKEDOWN

| | |
|--|----------|
| Fee received from 1. June to 25. July. | |
| Entrant (2 hours) | € 200,00 |

The price includes:

- VAT 27%
- Insurance
- SHAKEDOWN Road Book
- SHAKEDOWN sticker
- Rescue and Medical preparedness

CONDITIONS TO PARTICIPATE:

- Driver and co-driver must be registered in the Entry Form of HunGarian Baja 2022;
- The vehicle must be the one indicated in the entry form of HunGarian Baja 2022;
- The vehicles must have passed the pre-event scrutineering
- The shakedown fee must be paid;

SHAKEDOWN'S PLATES

To participate at the Shakedown, all identification and advertising panels received at the administrative check, including the Shakedown sticker (1 strip 25 cm x 10 cm to the centre top of the windscreen) must be affixed to the racing vehicle.

SERVICE AREA: Close to the Shakedown zone, the Organiser will provide an area where it will be possible to service on the race vehicles.

RUNNING OF THE SHAKEDOWN

Inside the race car, there will be both competitors registered at the HunGarian Baja 2022 and they must wear FIA homologated clothing and equipment, in accordance with Appendix L. All vehicles will start with an interval of 2 (two) minutes: the starting order will be based on their arrival at the preset zone and they can make as many laps as they wish in two hours.

After the Shakedown participants must put their cars in the Park Ferme 12:00-15:00 05th August 2022.

Art. 11.13 Onboard Cameras

Onboard cameras can be fitted if requested (on the Entry Form) and installed according Art 283-2 and Art. 11 of the 2022 FIA CCRSR.

Art. 11.14 Briefing

The briefing for competitors and Road Book delivery will take place according the program (see SR Art.3) Roadbook delivery will be at the Briefing.

Art. 11.15 Reconnaissance

As from the publication of the Supplementary Regulations, the presence of a competitor, or anyone connected with a competitor, on any part of the itinerary of an event is prohibited. (Art. 28 of the 2022 FIA CCR SR)

Art. 12. Identification of officials

| | |
|------------------------------|---|
| Competitors Relation Officer | <i>"CRO" Pink tabard</i> |
| Scrutineers | <i>"ATB" Blue tabard or shirt</i> |
| Post Chiefs: | <i>"VEZETŐBÍRÓ" Red tabard</i> |
| Special Stage Commanders: | <i>"VEZETŐBÍRÓ" Red tabard</i> |
| Marshals: | <i>"SAFETY" / "SPORTBÍRÓ" Yellow tabard</i> |
| Timekeepers: | <i>"CHRONOMOTO" Black shirt</i> |

Art. 13. Prizes

| | |
|-------------------------|-------------------------|
| Overall classification: | <i>1-3 places: Cups</i> |
| Group Classification: | <i>1-3 places: Cups</i> |

Prizes only will be awarded to crews present at the prize-giving ceremony. Absent crews will lose their right to get the prizes.

Vehicles entered in a class with less than 6 entrants will be competing only for the general classification and respective group classification.

Art. 14. Final checks / Protests / Appeals

Art. 14.1 Final Checks

Time and location: see programme (SR. Art. 3)
Location: Suzuki Mészáros, Grábler Tó str. 10.

Any teams required to undergo final checks must immediately follow the instruction of the marshals in charge, even if this prevents them from proceeding to one or more time controls (TC). The complete original FIA homologation form, the FIA Passport and other necessary certifications must be available for final checks.

Art.14.2 Protest deposit

The protest deposit is: **EUR 1.000**

If a protest requires the dismantling and re-assembly of a clearly defined part of the car, any additional deposit will be specified by the Stewards upon a proposal of the Chief Scrutineer (FIA International Sporting Code Art. 13.4.3)

Art. 14.3 Appeal deposit

The appeal deposit for an international appeal is published on the FIA website:
<https://www.fia.com/international-court-appeal>

All protests and/or appeals must be lodged in accordance with Articles 13 and 15 of the FIA International Sporting Code and, where applicable, with the FIA Judicial and Disciplinary Rules.

Art. 14.4 Fines

In accordance with Article 12.8 FIA International Sporting Code, the payment of the fines must be done online, within 48 hours of their notification, at the following address: <https://fiafines.fia.com>

Any delay in making payment may entail Suspension during the period a fine remains unpaid.

Appendix 1 – Itinerary



HUNGARIAN BAJA

CAR

| Leg 1 | | 2022.08.05. FRIDAY / PÉNTEK | | | | | | |
|---|--|-----------------------------|--------|------------|----------|----------------------------|-----------------|--|
| Sunrise 5:29 | | 20:17 Sunset | | | | | | |
| IE/TC | Location | SS Maximum Time | SS Km | Liasion Km | Total Km | Target Time | 1st vehicle Due | |
| TC0 | VÁRPALOTA Parc Ferme OUT | | | | | | 17:45 | |
| TC1 | Várpalota | | | 3,33 | 3,33 | 0:10 | 17:55 | |
| DQS 1 | QS1 START | | | | | 0:05 | 18:00 | |
| AQS 1 | QS1 FINISH | 0:30 | 7,31 | | 10,64 | (0:05) | (18:05) | |
| | Várpalota | | | | | (Expected time of arrival) | | |
| RZ 1 | Refueling, Petrol Station, 14km, | | | | | | | |
| TC1A | Service IN (FIA Tire marking) | | | 3,95 | 14,59 | 0:25 | 18:30 | |
| SERVICE A | | | | | | | | |
| TC1B | Service OUT (FIA Tire marking) | | | 0,83 | 15,42 | 1:05 | 19:35 | |
| TC1C | Regrouping IN | | | 0,51 | 15,93 | 0:05 | 19:40 | |
| REGROUPING / START POSITION CHOOSING for LEG1 Section 2 - ONLY for the TOP 10 on Podium | | | | | | | 21:00 | |
| TC1D | Regrouping OUT / Podium Start Ceremony | | | | | | 21:30 | |
| TC1E | Parc Ferme IN / Early Check-IN is Authorised | | | 0,15 | 16,08 | 0:30 | 22:00 | |
| Day Total | | | 7,31 | 8,77 | 16,08 | | | |
| | | | 45,46% | 54,54% | 100% | | | |

Section 1



HUNGARIAN BAJA

CAR

| Leg 1 | | 2022.08.06. SATURDAY / SZOMBAT | | | | | | |
|---------------------|--|--------------------------------|--------|------------|----------|-------------|----------------------------|--|
| Sunrise 5:30 | | 20:15 Sunset | | | | | | |
| IE/TC | Location | SS Maximum Time | SS Km | Liasion Km | Total Km | Target Time | 1st vehicle Due | |
| TC1F | Parc Fermé OUT | | | | | | 10:00 | |
| TC2 | Várpalota | | | 2,63 | 2,63 | 0:10 | 10:10 | |
| DSS 2A | START | | | | | 0:05 | 10:15 | |
| ASS 2A | FINISH | 2:00 | 81,96 | | 84,59 | (0:55) | (11:10) | |
| | Gyulaifirátót | | | | | | (Expected time of arrival) | |
| Neutralization zone | | | | | | | | |
| | Gyulaifirátót | | | 1,52 | 86,11 | 0:15 | 11:25 | |
| DSS 2B | START | | | | | | 11:25 | |
| ASS 2B | FINISH | 1:40 | 56,08 | | 142,19 | (0:40) | (12:05) | |
| | Újmajor | | | | | | (Expected time of arrival) | |
| RZ 2 | Refueling, Petrol Station, 14km, | | | | | | | |
| TC2A | Service IN (FIA Tire marking) | | | 33,01 | 175,20 | 0:50 | 12:55 | |
| SERVICE / SZERVIZ B | | | | | | | | |
| TC2B | Service OUT (FIA Tire marking) | | | 0,83 | 176,03 | 0:40 | 13:35 | |
| TC2C | Regrouping IN | | | 0,51 | 176,54 | 0:05 | 13:40 | |
| REGROUPING | | | | | | | | |
| TC2D | Regrouping OUT | | | | | | 14:15 | |
| TC3 | Várpalota | | | 2,63 | 179,17 | 0:10 | 14:25 | |
| DSS 3A | START | | | | | 0:05 | 14:30 | |
| ASS 3A | FINISH | 2:00 | 81,96 | | 261,13 | (0:55) | (15:25) | |
| | Gyulaifirátót | | | | | | (Expected time of arrival) | |
| Neutralization zone | | | | | | | | |
| | Gyulaifirátót | | | 1,52 | 262,65 | 0:15 | 15:40 | |
| DSS 3B | START | | | | | | 15:40 | |
| ASS 3B | FINISH | 1:40 | 56,08 | | 318,73 | (0:40) | (16:20) | |
| | Újmajor | | | | | | (Expected time of arrival) | |
| RZ 3 | Refueling, Petrol Station, 14km, 14,00 | | | | | | | |
| TC3A | Service IN (FIA Tire marking) | | | 33,01 | 351,74 | 0:50 | 17:10 | |
| SERVICE / SZERVIZ C | | | | | | | | |
| TC3B | Service OUT (FIA Tire marking) | | | 0,83 | 352,57 | 1:20 | 18:30 | |
| TC3C | Parc Ferme IN / Early Check-IN is Authorised | | | 0,51 | 353,08 | 0:05 | 18:35 | |
| Day Total | | | 276,08 | 77,00 | 353,08 | | | |
| | | | 78,19% | 21,81% | 100% | | | |

Section 2

Section 3



HUNGARIAN BAJA

CAR

| Leg 2 | | 2022.08.07. SUNDAY / VASÁRNAP | | | | | | |
|----------------------------------|--|-------------------------------|--------|------------|----------|-------------|----------------------------|--|
| Sunrise 5:31 | | 20:14 Sunset | | | | | | |
| IE/TC | Location | SS Maximum Time | SS Km | Liasion Km | Total Km | Target Time | 1st vehicle Due | |
| TC3D | Parc Fermé OUT | | | | | | 10:00 | |
| TC4 | Gyulafirátót | | | 27,49 | 27,49 | 0:40 | 10:40 | |
| DSS 4 | START | | | | | 0:05 | 10:45 | |
| ASS 4 | FINISH | 1:40 | 66,26 | | 93,75 | (0:45) | (11:30) | |
| | Várpalota | | | | | | (Expected time of arrival) | |
| RZ 4 | Refueling, Petrol Station, 14km. | | | | | | | |
| TC4A | Service IN (FIA Tire marking) | | | 3,95 | 97,70 | 0:25 | 11:55 | |
| SERVICE / SZERVIZ D | | | | | | | | |
| TC4B | Service OUT (FIA Tire marking) | | | 0,83 | 98,53 | 0:40 | 12:35 | |
| TC4C | Regrouping IN | | | 0,51 | 99,04 | 0:05 | 12:40 | |
| REGROUPING | | | | | | | | |
| TC4D | Regrouping OUT | | | | | | 13:15 | |
| TC5 | Gyulafirátót | | | 27,49 | 126,53 | 0:40 | 13:55 | |
| DSS 5 | START | | | | | 0:05 | 14:00 | |
| ASS 5 | FINISH | 1:40 | 66,26 | | 192,79 | (0:45) | (14:45) | |
| | Várpalota | | | | | | (Expected time of arrival) | |
| TC5A | Parc Ferme IN / Early Check-IN is Authorised | | | 3,62 | 196,41 | 0:10 | 14:55 | |
| Prize Giving and Podium Ceremony | | | | | | | 17:00 | |
| Day Total | | | 132,52 | 63,89 | 196,41 | | | |
| | | | 67,47% | 32,53% | 100% | | | |
| | | | SS km | Liasion km | Total km | | | |
| Rally Total | | | 415,91 | 149,66 | 565,57 | | | |
| | | | 73,54% | 26,46% | 100% | | | |

Section 4

Section 5

Appendix 2 Names and photographs of the Competitors Relation officer(s) and their schedules



(ENG + HUN)
Mrs. Marianna MAGYAR KELEMENNÉ
+36 70 944 5148



(ENG + HUN)
Mr. István MÁTRAI
+36 20 417 6249

Estimated working plan:







| | | |
|------------------------|--|---|
| Thursday 04. August | Admin check Scrutineering | 08:00-19:00 10:00-21:00 |
| Friday 05. August | Parc ferme Briefing / Start TC / Start Ceremony | 12:00-15:00 16:00-22:00 |
| Saturday 06. August | Parc ferme Service area Parc ferme Service area Parc ferme | 08:00-10:00 11:00-13:00 13:00-14:00 14:00-16:00 17:00-19:00 |
| Sunday 07. August | Parc ferme Service area PF/Parc ferme / Finish Ceremony | 08:00-10:00 10:00-11:00 12:00-18:00 |

Appendix 3 – Decals and positioning of supplementary advertising

List and positioning of advertising

 **FIA** **Mandatory stickers placement.**

ADVERTISING

1  1  1  2  2*  3*  1 

* According FIA CCR GP

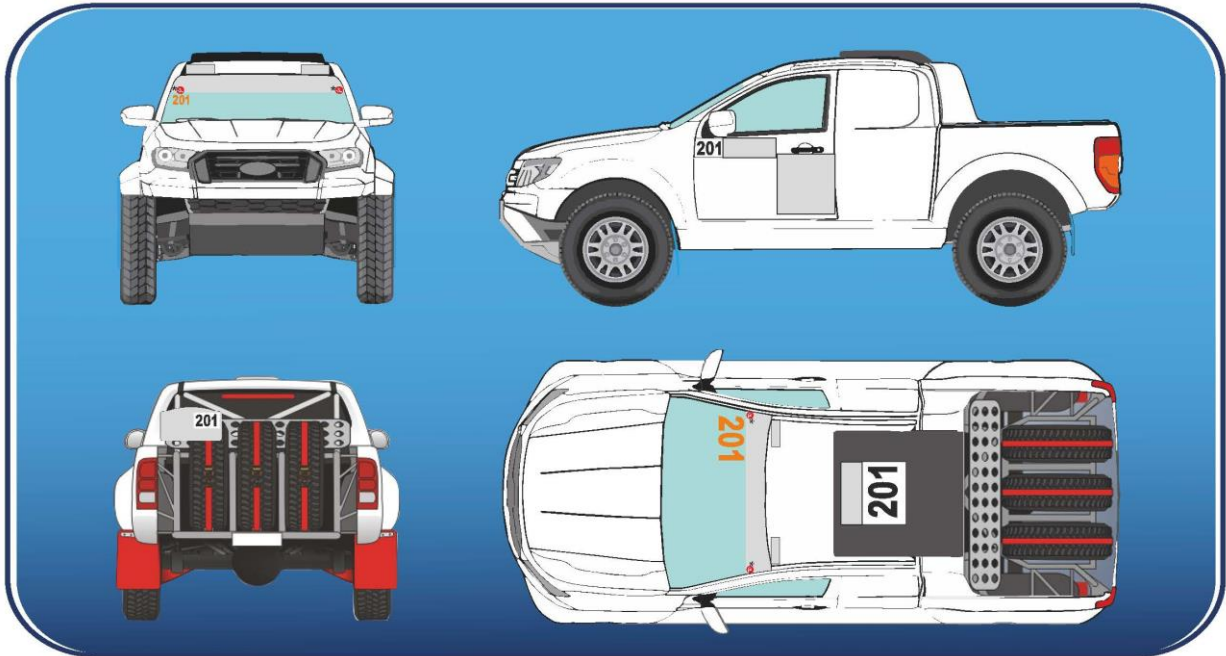

Optional stickers:

Additional organiser's advertising: Will be published in a Bulletin.

Size: 50x50cm

For T3, T4: 30x30cm

Appendix 4 – Extracts from FIA ISC Appendix L relating to overalls, helmets and any other safety requirements

All competitors are reminded of Appendix L of the FIA International Sporting Code, in particular its Chapter III - Drivers' Equipment.

Helmets (Appendix L, Chapter III, Art. 1)

All crews must wear crash helmets homologated to one of the following FIA standards listed in Appendix L.

Frontal Head Restraint (FHR, Appendix L, Chapter III, Art. 3)

All crews must use FIA approved FHR systems homologated to FIA standard 8858.

Approved FHRs, anchorages and tethers are listed in Technical List N° 29.

See also helmet compatibility chart in Appendix L, Chapter III, Art. 3.3.

Flame-resistant clothing (Appendix L, Chapter III, Art. 2)

All drivers and co-drivers must wear overalls as well as gloves (optional for co-drivers), long underwear, a balaclava, socks and shoes homologated to the FIA 8856-2000 standard (Technical List N°27) or 8856-2018 (Technical List N° 74). Please pay special attention to the prescriptions of Art. 2 concerning embroidery and printing on flame-resistant clothing (manufacturer certificates etc.) **as well as concerning the correct wearing of the clothing elements! See also FIA Cross-Country Rally Sporting Regulations Article 48.1.**

Biometric Devices (Appendix L, Chapter III, Art. 2.1)

Drivers may wear a device to collect biometric data during racing.

- If the biometric device is integrated into a protective garment homologated to FIA Standard 8856, the garment shall be homologated to FIA Standards 8856 and 8868-2018.
- If the biometric device is a stand-alone device, then the device must be homologated to FIA Standard 8868-2018 only. This device must be worn in addition to the garment homologated to FIA Standard 8856.

Wearing of jewellery (Appendix L, Chapter III, Art. 5)

The wearing of jewellery in the form of body piercing or metal neck chains is prohibited during the competition and may therefore be checked before the start.

MEDICAL AND SURVIVAL KIT (Appendix III of the Cross-Country Rally Sporting Regulations)

A sealed and valid Medical kit in accordance with the Specification for Cross Country Rallies and Bajas (Technical List n°83) must be placed inside the cockpit. The minimum weight must comply with Technical List n°83.

| |
|---|
| RELATED LINKS: |
| FIA International Sporting Code and appendices: https://www.fia.com/regulation/category/123 |
| FIA Technical Lists: https://www.fia.com/regulation/category/761 |



MAIN SCREEN

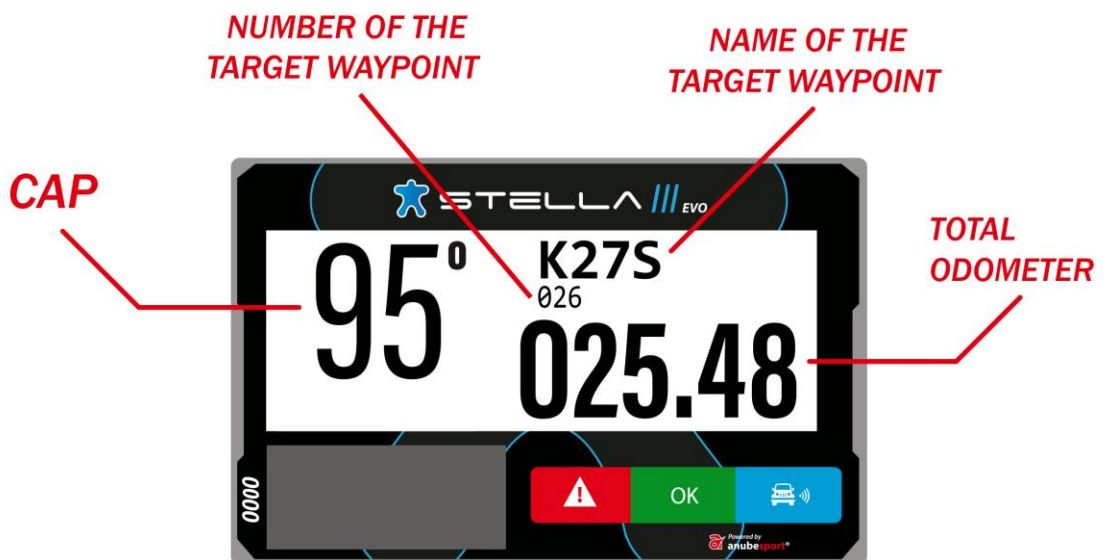

WAYPOINT PROXIMITY

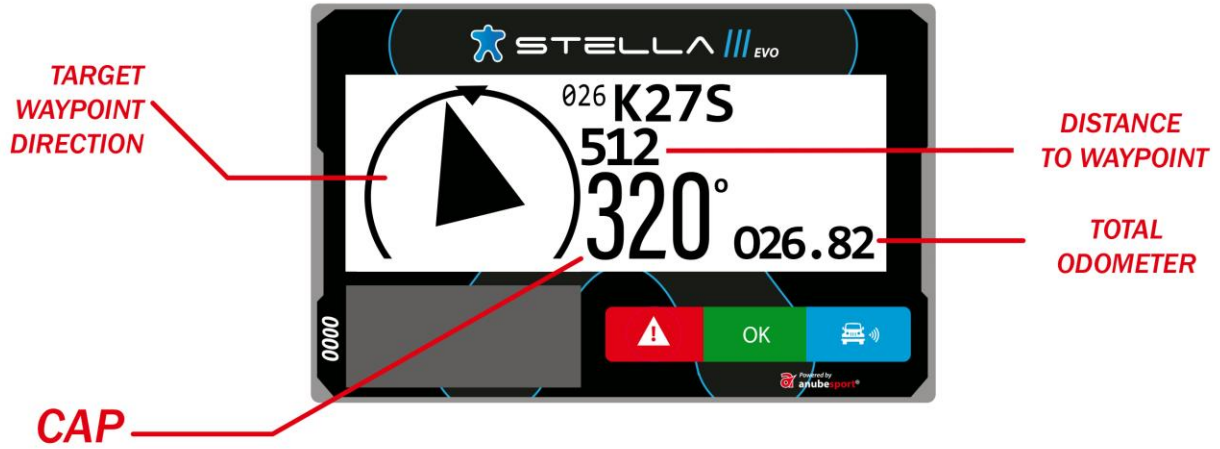

SPEED ZONE

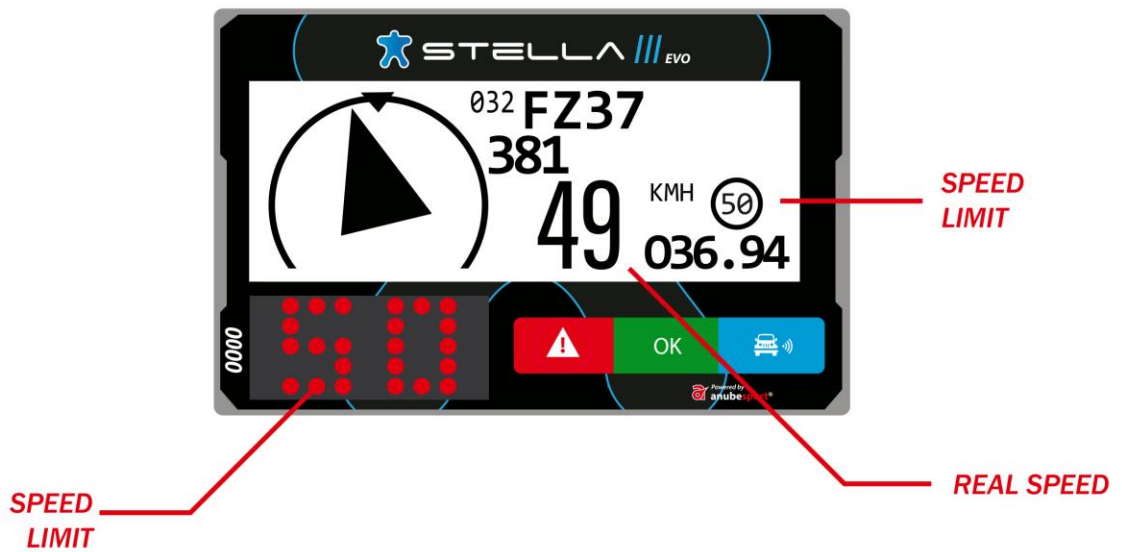

REQUEST MEDICAL ATTENTION IMMEDIATELY



SOS

1 sec.



CAUTION VEHICLE STATIONARY



3 sec.
BREAKDOWN



DANGER 3 !!!



Notification 300m before an area marked in the roadbook as "Danger 3"

OVERTAKING / BLUE FLAG



OVERTAKING / BLUE FLAG



STEADY



FLASHING



OVERTAKING / BLUE FLAG



FREE TO OVERTAKE



STEADY

PRESS THE BLUE BUTTON TO CONFIRM

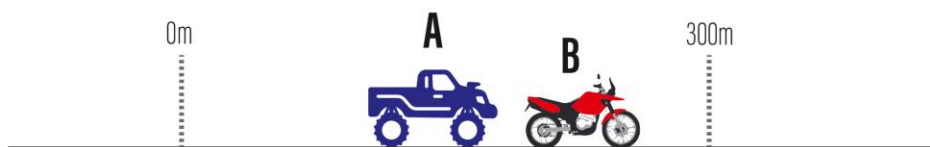

SPEED LIMIT

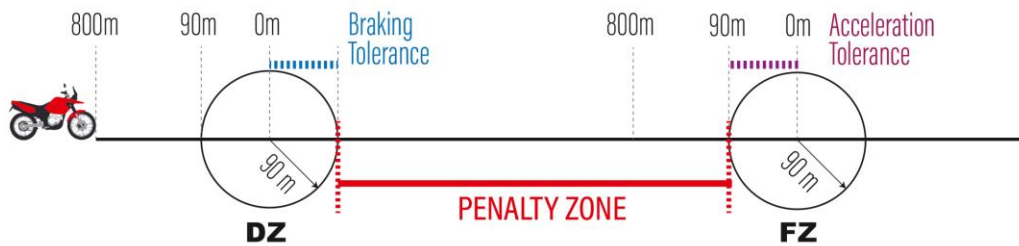
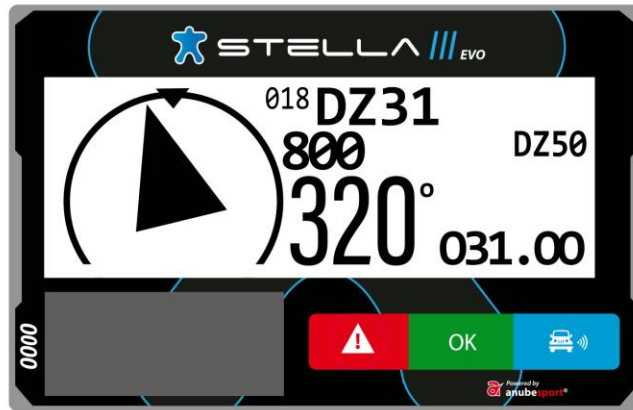

SPEED LIMIT

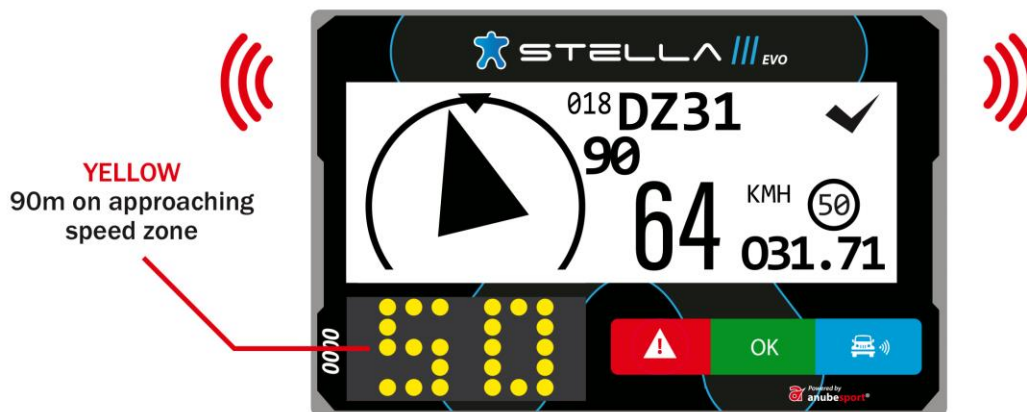

YELLOW
90m on approaching speed zone

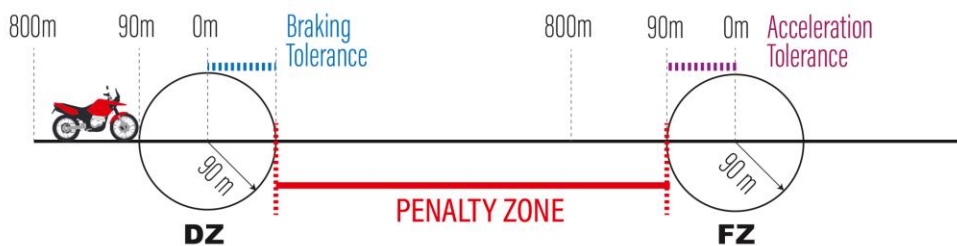

SPEED LIMIT



RED STEADY Inside of speed zone
RED FLASHING Overspeed

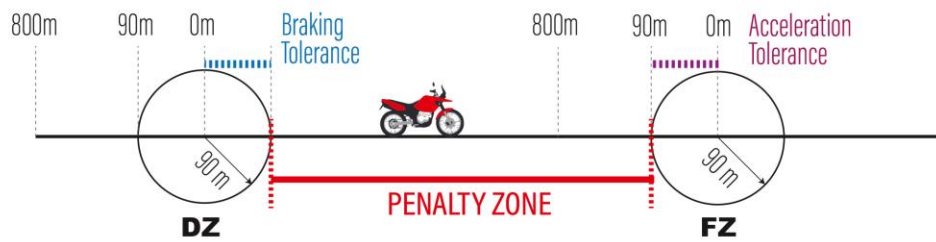

SPEED LIMIT



OFF end of speed zone

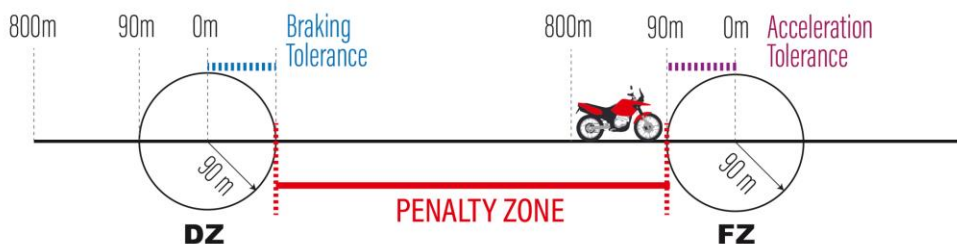
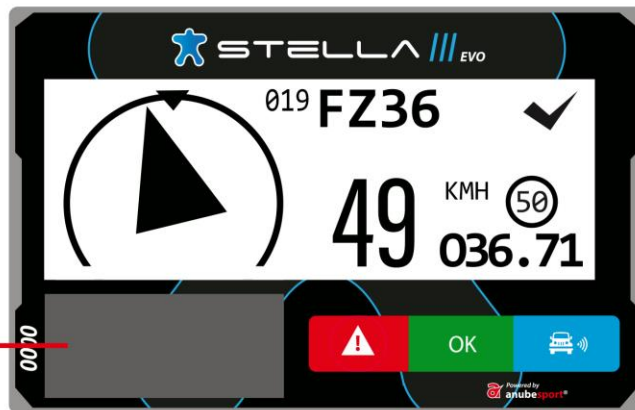

NEUTRALIZATION ZONE

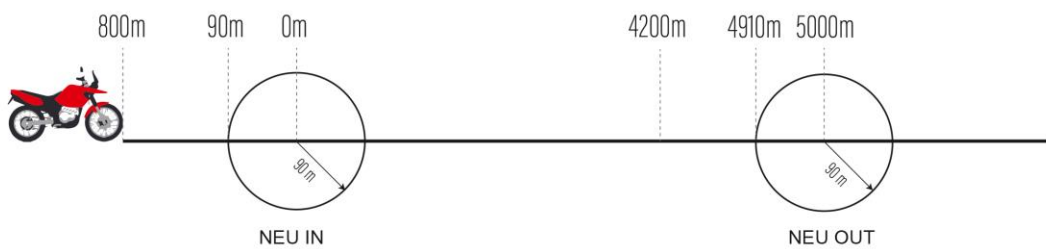
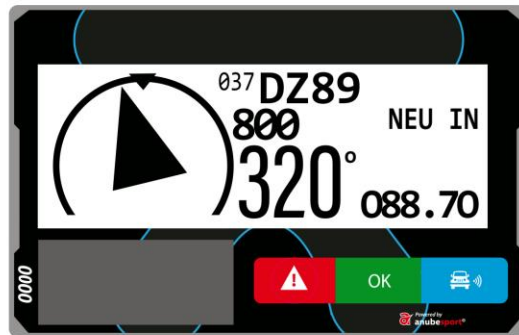

NEUTRALIZATION ZONE

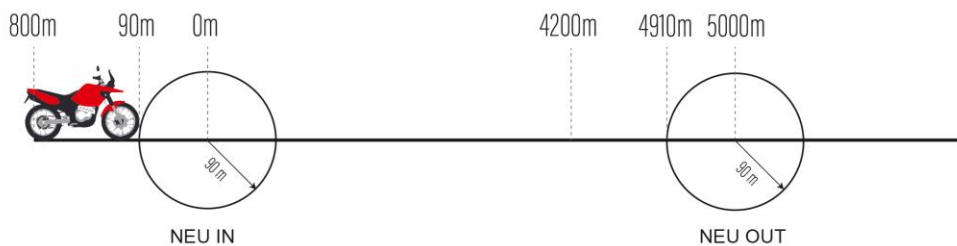
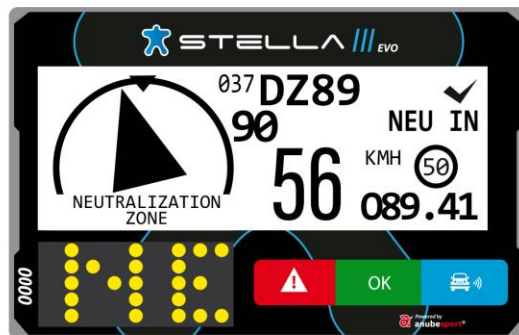

NEUTRALIZATION ZONE

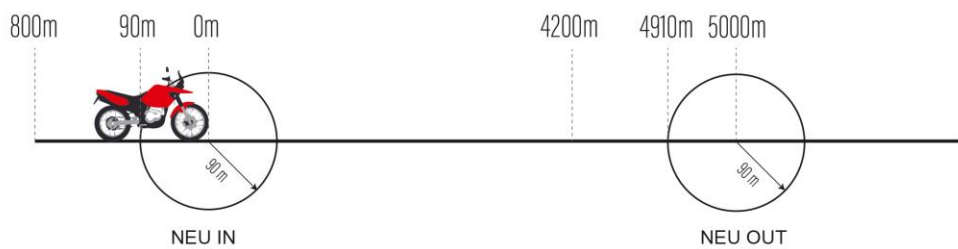
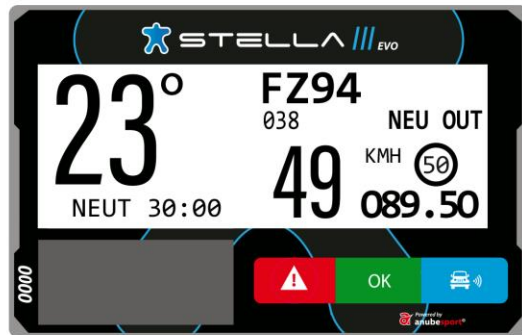

NEUTRALIZATION ZONE

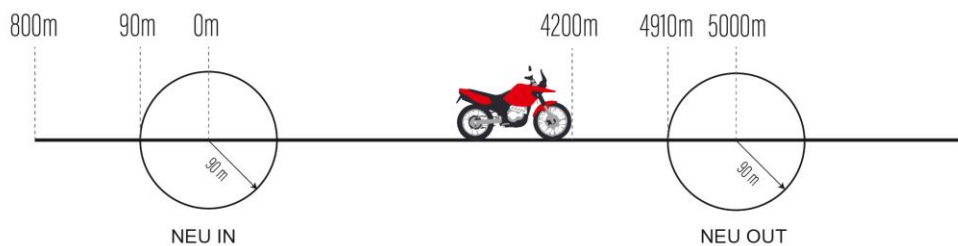
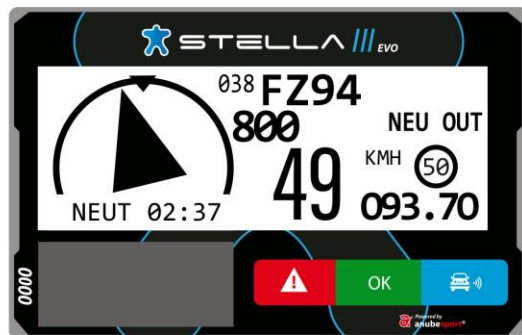

NEUTRALIZATION ZONE

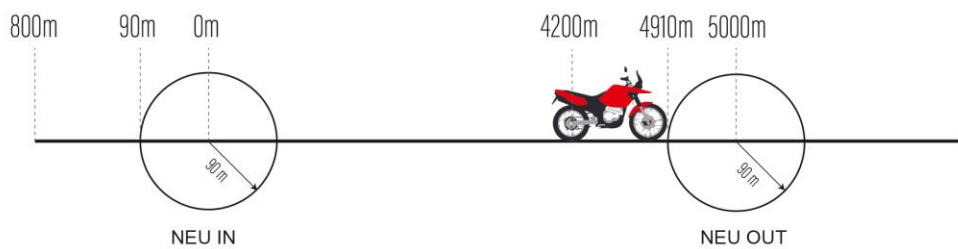
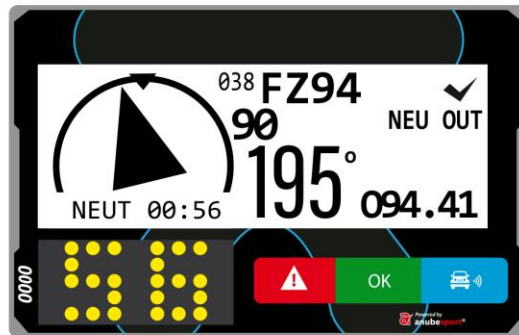

NEUTRALIZATION ZONE

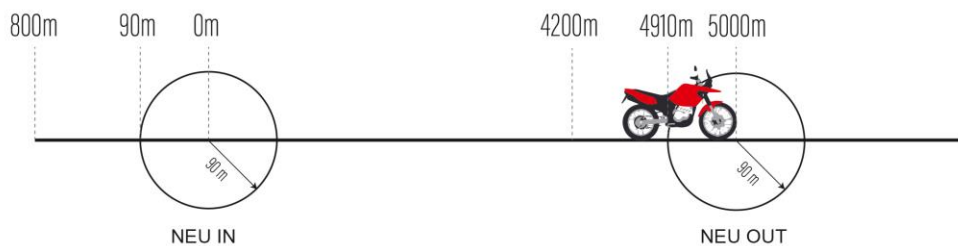

MESSAGES

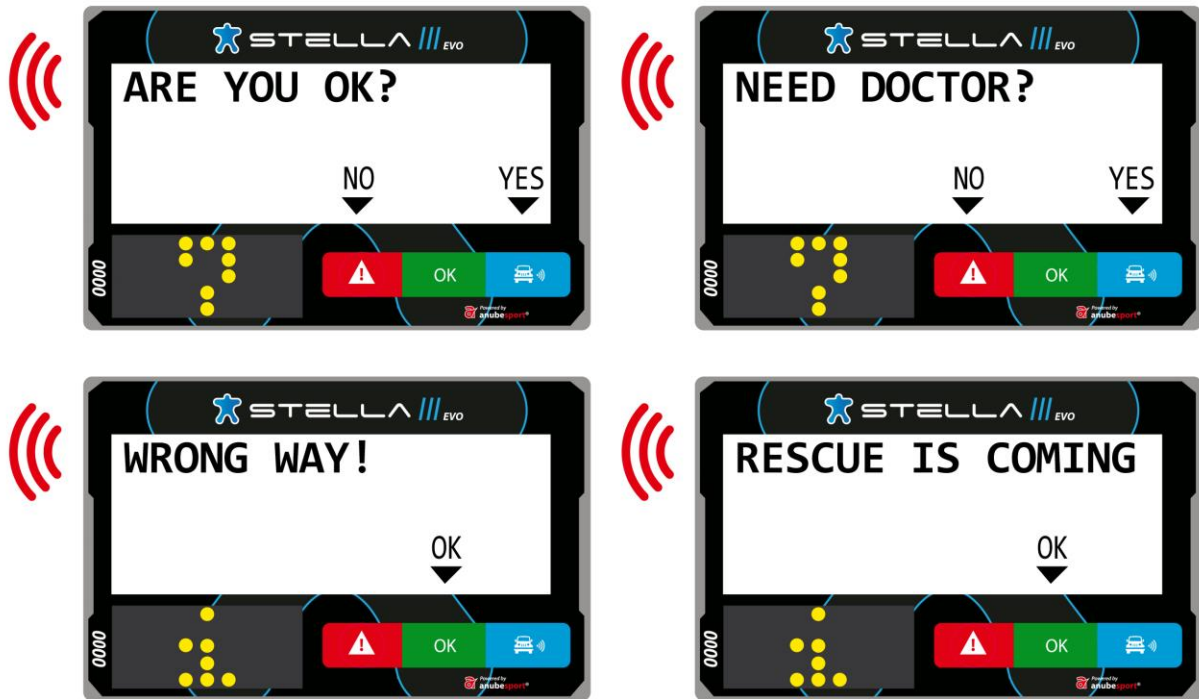

WAYPOINTS LIST



TOTAL ODOMETER RESET TO ZERO



OK

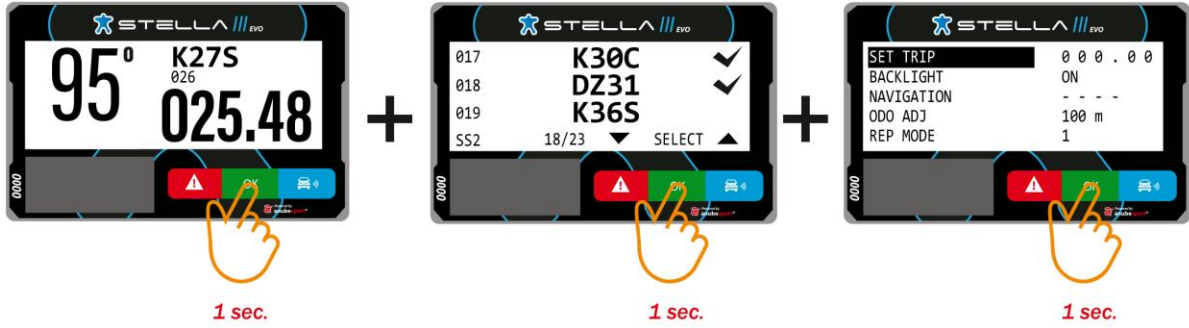

APPENDIX 6:

Kit components and Instructions for the use of the car-to-car communication system

KIT COMPONENTS

60 €



1. Iridium Antenna
2. Power Cord
3. RF Cord
4. RF Antenna
5. Base/Mount
6. GPS Antenna
7. Adhesive
8. Straps
9. User Manual

IMPORTANT

For the functional tests and verification, all vehicles must have gone through the installation of the mount, power cord, and antennas.

The radio-frequency antenna must be installed vertically to the roll cage bars (cars and SSV) and the forks (ATV). It is mandatory to use separators (included in the kit) to avoid contact with metallic parts and the carbon fibre that surrounds it. Once the antennas are mounted, take the SMA connection cords to the base/mount where the STELLA III EVO will be installed.

1. POWER CORD

- Connect the red wire to the positive end of the battery 12V(+), and the grey wire to the negative end (GRD). The power cord must be connected directly to the battery (without interruptions and without contact in the power supply).
- A 3A fuse (not included) should be connected to the red wire.
- Take the cord to the location in which the STELLA III EVO is to be installed. All other wires must be insulated, they cannot touch.



2. BASE/MOUNT

- Motorcycles and ATV: The mount can be attached to the handle bar or to a metal plaque close to the navigation system.
- Cars and UTV: The mount can be attached to the panel, or to the roll cage bars. STELLA III EVO buttons must be visible and accessible to the participant (pilot/navigator) even when they are sitting and with the seatbelts buckled.

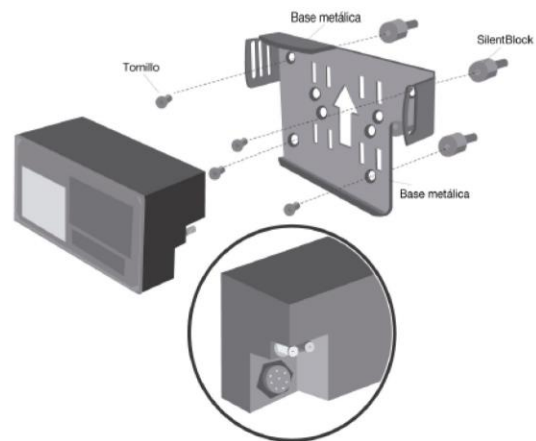

IMPORTANT

Leave the cords (antenna and battery) in place with at least 10 cm to spare for easy handling.
At least 5 cm of space behind the mount (bottom right corner) to allow space for power cord/connections.

3. GPS ANTENNA

The GPS antenna must be installed horizontally and without obstructions toward the sky. In cars and UTV, It can be mounted on the roof, the hood, or the dashboard. In motorcycles and ATV, attach to the mudguard. For additional firmness, it is recommended to cover it with adhesive tape (non metallic when mounting it to a metallic surface) and pull-up (when attached to soft or plastic parts).



4. ANTENNA IRIDIUM

The Iridium antenna must be installed horizontally and without obstructions toward the sky. In cars and UTV, It can be mounted on the roof, the hood, or the dashboard. In motorcycles and ATV, attach to the mudguard. For additional firmness, it is recommended to cover it with adhesive tape (non metallic when mounting it to a metallic surface) and pull-up (when attached to soft or plastic parts).



5. RF ANTENNA

The radio-frequency antenna must be installed vertically to the roll cage bars (cars and UTV) and the forks (motorcycles and ATV). It is mandatory to use separators (included in the kit) to avoid contact with metallic parts and the carbon fibre that surrounds it.

Once the antennas are mounted, take the SMA connection cords to the base/mount where the STELLA III EVO will be installed.

